

Varenummer: 20081472
Beskrivelse: E+G Indstilleligt spændegreb
GN 302-63-M8-SW, sort

Mål

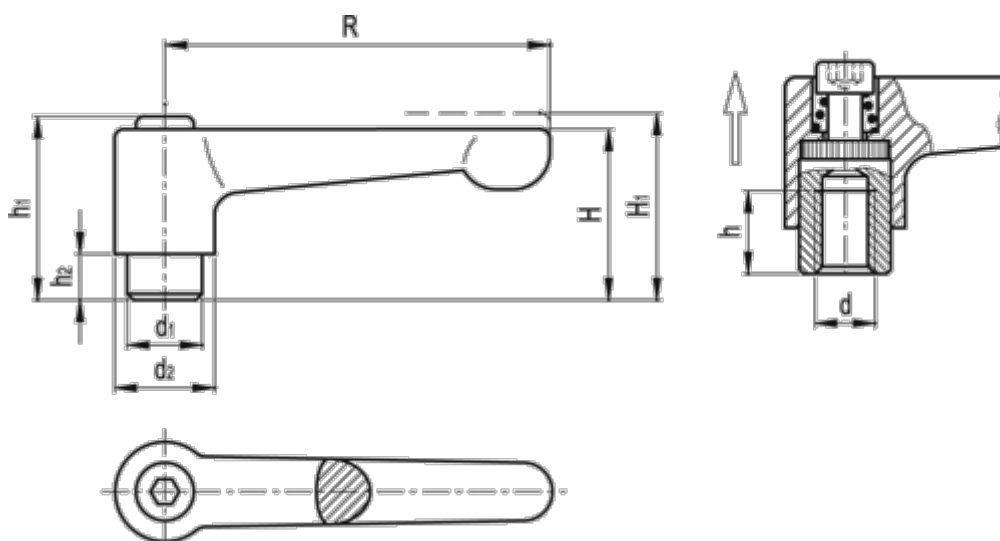

d = M8	R = 63
d1 = 13.5	Vægt (g) = 72
d2 = 17.5	
h = 11	
H = 28.5	
h1 = 31.0	
H1 = 32.5	
h2 = 6.5	